

Connecting cord assy (E30-6145-05)

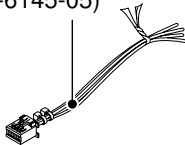

Accessory (W01-1606-05)

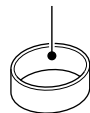

Screw set (N99-1587-05)

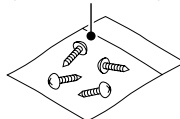

Control assy ❖

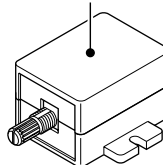

Modular cable (E30-6240-15) ❖

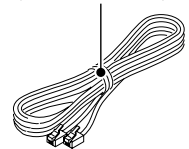

Screw set (N99-1740-05) ❖

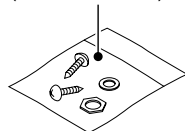

Dressing plate (B03-5024-14) ❖

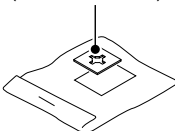

Knob (K23-1076-03) ❖



❖ KAC-8151D only.



KAC-8101D/8151D

BLOCK DIAGRAM

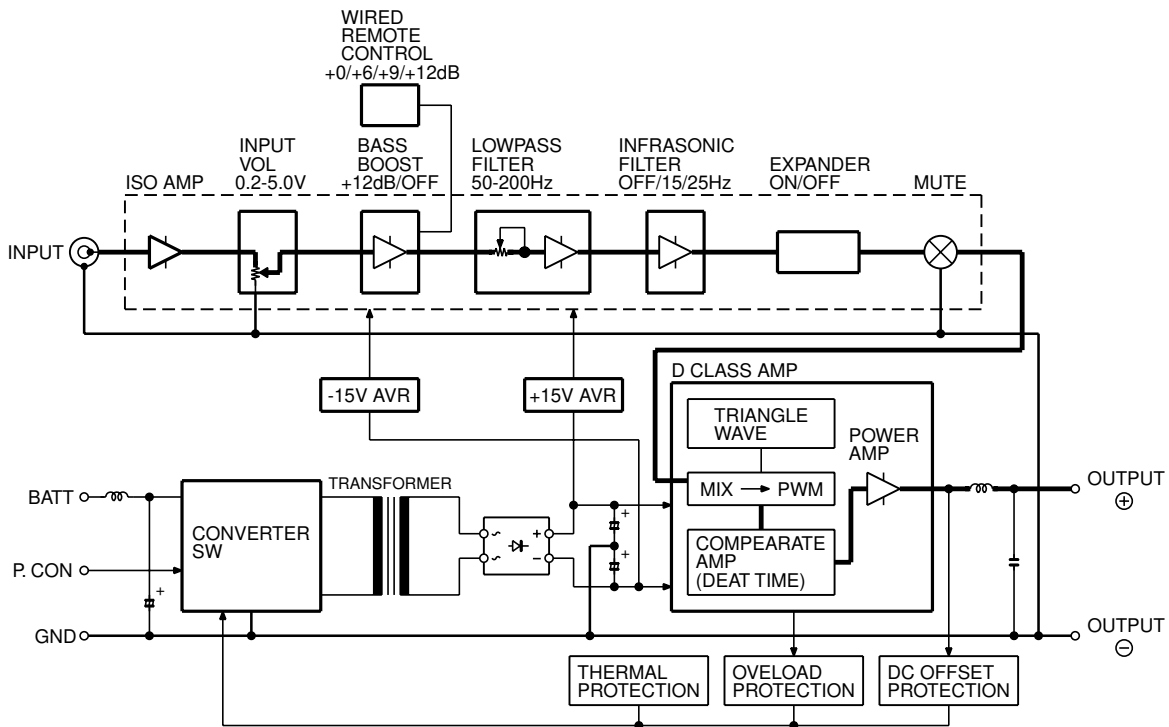

COMPONENTS DESCRIPTION

AUDIO UNIT (X09-5480-1x)

Ref No.	Application / Function
IC1	Isolation amplifier
IC2	Bus boost amplifier
IC3	(1/2) : Lowpass filter amplifier (2/2) : Infrasonic amplifier
IC4	Expander amplifier
IC5	DC detection rectification amplifier
IC6	Expander detection and difference output
IC7	(1/2) : Triangular waveform generation (2/2) : Summing amplifier
IC8	(1/2) : ASO (current, voltage comparison) detection (2/2) : DC converter control
IC9	(1/2) : Triangular waveform generation (2/2) : PWM waveform generator
IC10,11	Dead time generator
IC12	Bus boost level changer
IC15	DC/DC converter
Q1	Mute
Q3~5	Output FET control (current amplifier)
Q7~10	Output FET control (current amplifier)
Q11~14	Output FET driver

Ref No.	Application / Function
Q15,16	Output FET
Q17~20	Speaker output current detection
Q21,22	Output FET control power supply and control
Q23~25	DC protection
Q26,27	ASO DC detection
Q28	IC8 (2/2) output logic invert
Q31	Reduced voltage protection
Q32	Over voltage protection
Q34	DC/DC converter power supply
Q36	DC/DC converter control
Q37~40	Power FET driver
Q41~46	Power FET
Q47~50	Small-signal \pm power supply
Q51,52	When OFF, quick break in a circuit of \ominus power supply for small-signal circuit
Q53	Power FET control power supply
Q55	Mute, LED and protection control
Q61~64	Power FET driver
Q65,66	Power FET

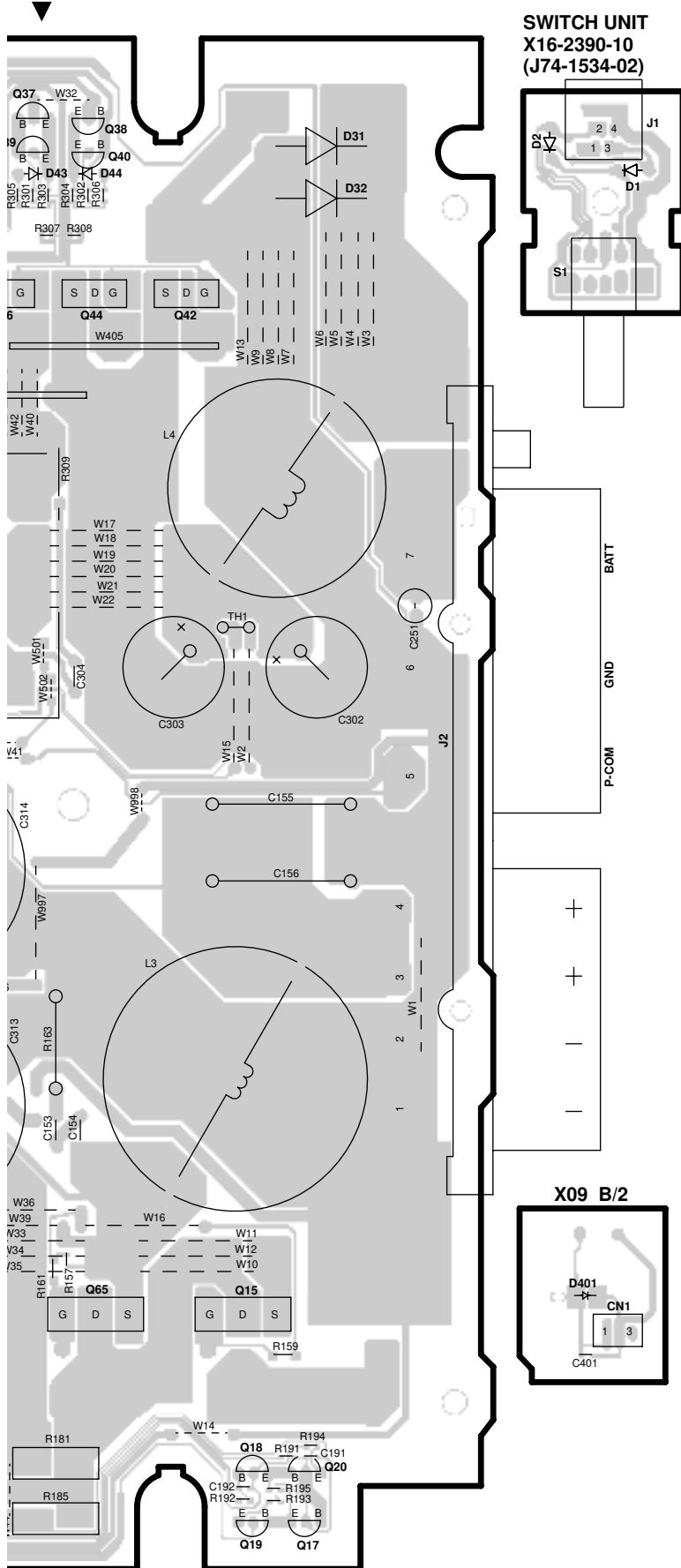

X09-5480-1x

IC	Q	Address	IC	Q	Address
1		3B		24	2B
2		5B		25	1B
3		5B		26	2B
4		6B		27	2B
5		2B		28	2B
6		7B		31	2D
7		5C		32	1D
8		2B		33	1C
9		5D		34	2C
10		5D		36	1D
11		5C		37	2E
12		5B		38	2F
15		2E		39	2E
	1	5C		40	2F
	3	6C		41	2E
	4	6C		42	2F
	5	6C		43	2E
	7	6C		44	2F
	8	6C		45	2D
	9	6C		46	2E
	10	6C		47	7C
	11	6D		48	7C
	12	6D		49	6D
	13	6D		50	6D
	14	6D		51	6C
	15	6F		52	6C
	16	6E		53	3C
	17	7G		55	2D
	18	7F		61	6D
	19	7F		62	6D
	20	7G		63	6D
	21	3C		64	6D
	22	3C		65	6F
	23	1B		66	6D

Refer to the schematic diagram for the values of resistors and capacitors.

KAC-8101D/8151D

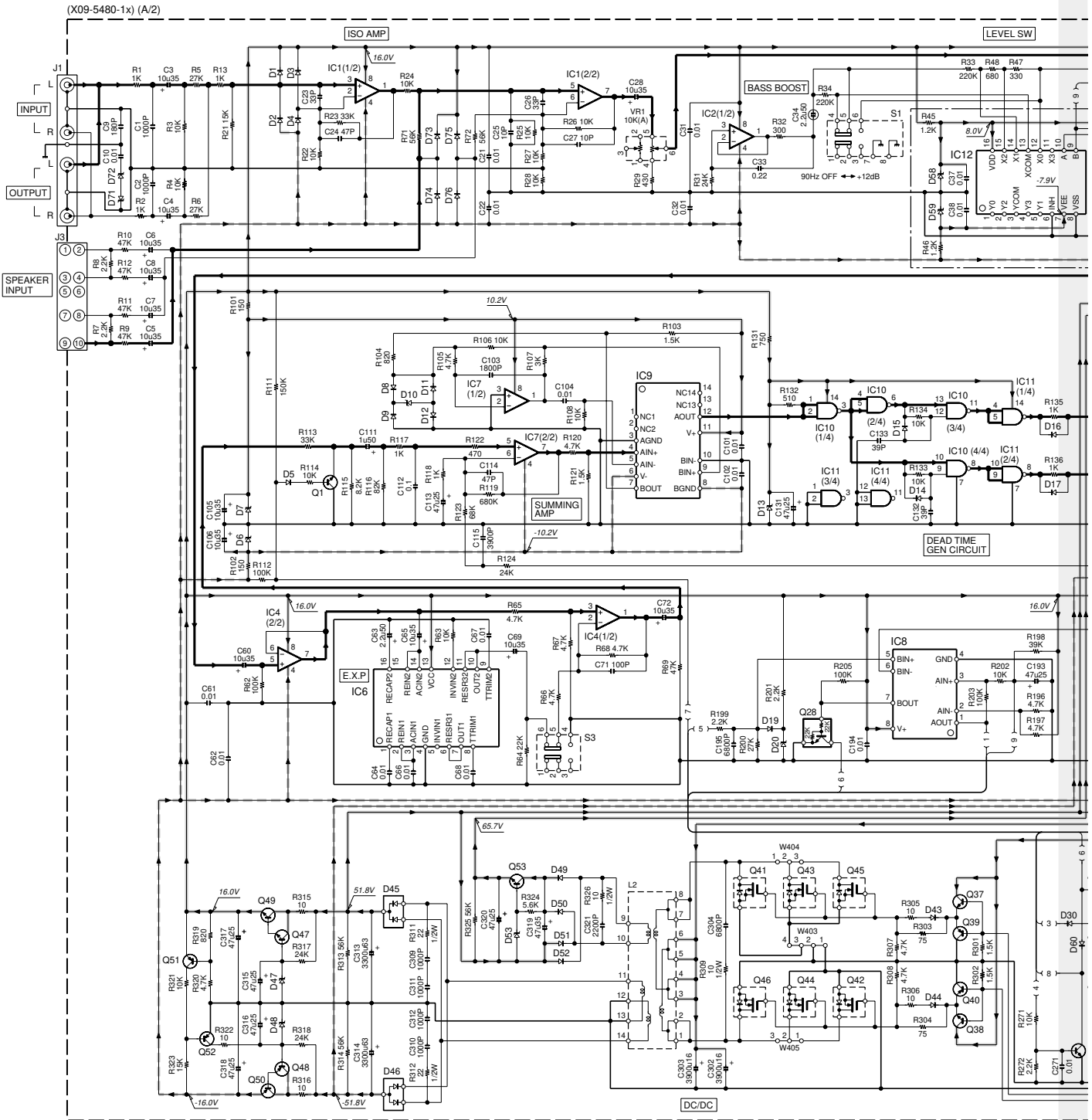

CAUTION : For continued safety, replace safety critical components only with manufacturer's recommended parts (refer to parts list).
 ⚠ Indicates safety critical components. To reduce the risk of electric shock, leakage-current or resistance measurements shall be carried out (exposed parts are acceptably insulated from the supply circuit) before the appliance is returned to the customer.

- DC voltages are as measured with a high impedance voltmeter. Values may vary slightly due to variations between individual instruments or/and units.

- 2SA1123
- 2SA1286-T11
- 2SA1534A
- 2SA733(A)
- 2SA992
- 2SC1845
- 2SC2631
- 2SC3940A
- 2SC945(A)

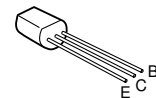

KAC-8101D/8151D

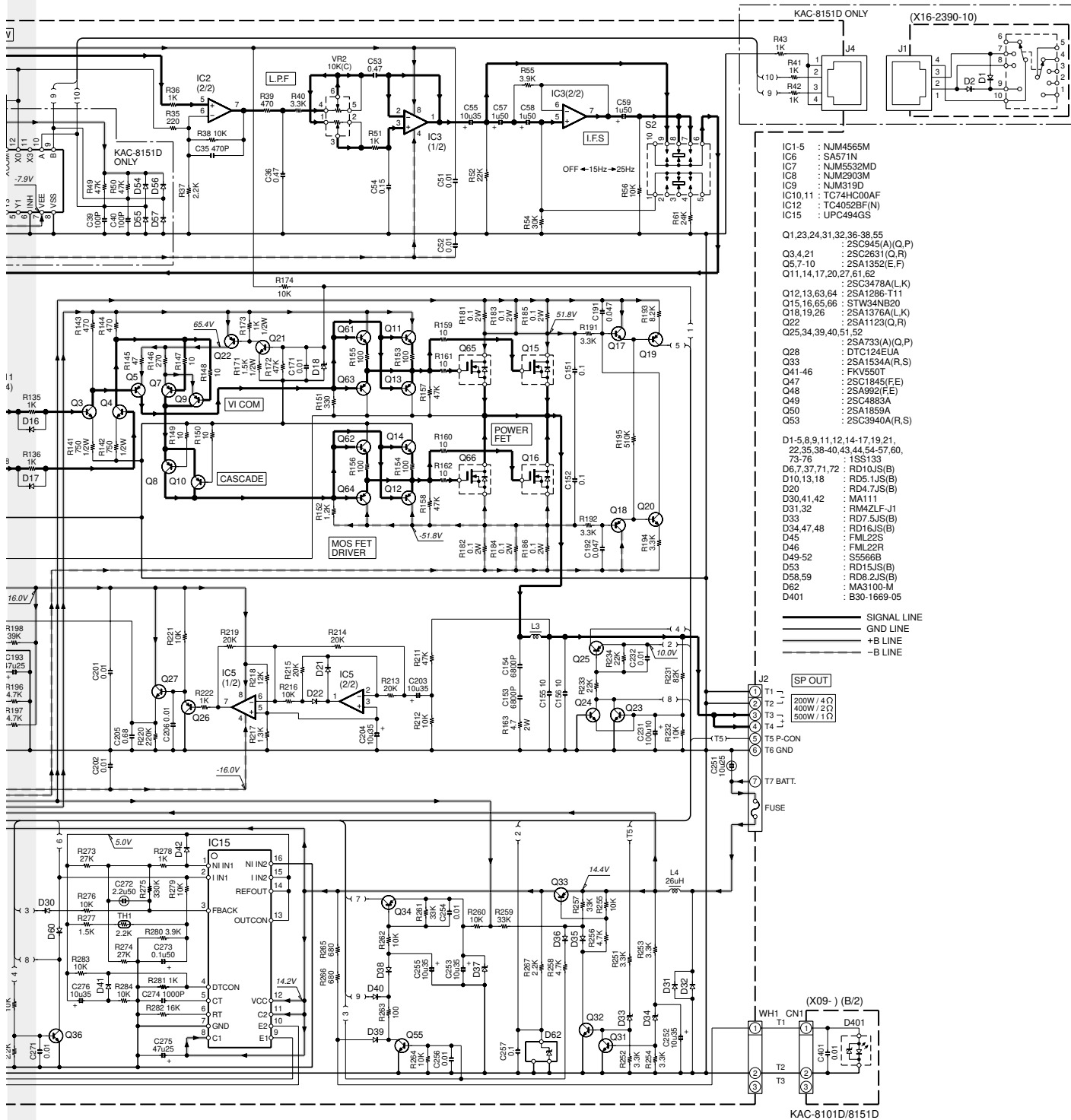

- KAC-8151D ONLY**
- (X16-2390-10)
- IC1-5 : NJM4565M
 - IC6 : SA571N
 - IC7 : NJM5532MD
 - IC8 : NJM2903M
 - IC9 : NJM319D
 - IC10,11 : TC74HC00AF
 - IC12 : TC4052BF(N)
 - IC15 : UPC494GS
- Q1,23,24,31,32,36-38,55 : 2SC945(A)(Q,P)
 - Q3,4,21 : 2SC2631(Q,R)
 - Q5,7-10 : 2SA1352(E,F)
 - Q11,14,17,20,27,51,52 : 2SC3478A(L,K)
 - Q12,13,63,64 : 2SA1286-T11
 - Q15,16,65,66 : STW34NB20
 - Q18,19,26 : 2SA1376A(L,K)
 - Q22 : 2SA1123(Q,R)
 - Q25,34,39,40,51,52 : 2SC3478A(L,K)
 - Q28 : DTC124EUA
 - Q33 : 2SA1534A(R,S)
 - Q41-46 : FKV550T
 - Q47 : 2SC1845(FE)
 - Q48 : 2SA992(FE)
 - Q49 : 2SC4883A
 - Q50 : 2SA1859A
 - Q53 : 2SC3940A(R,S)
- D1-5,8,9,11,12,14-17,19,21, 22,35,38-40,43,44,54-57,60, 73-76 : 1S133
 - D6,7,37,71,72 : RD10JS(B)
 - D10,13,18 : RD5,14S(B)
 - D20 : RD4,7JS(B)
 - D30,41,42 : MA111
 - D31,32 : RM4ZLF-J1
 - D33 : RD7,5JS(B)
 - D34,47,48 : RD16JS(B)
 - D45 : FML22S
 - D46 : FML22R
 - D49-52 : S5566B
 - D53 : RD15JS(B)
 - D58,59 : RD8,2JS(B)
 - D62 : MA3100-M
 - D401 : B30-1669-05
- D1-5,8,9,11,12,14-17,19,21, 22,35,38-40,43,44,54-57,60, 73-76 : 1S133
 D6,7,37,71,72 : RD10JS(B)
 D10,13,18 : RD5,14S(B)
 D20 : RD4,7JS(B)
 D30,41,42 : MA111
 D31,32 : RM4ZLF-J1
 D33 : RD7,5JS(B)
 D34,47,48 : RD16JS(B)
 D45 : FML22S
 D46 : FML22R
 D49-52 : S5566B
 D53 : RD15JS(B)
 D58,59 : RD8,2JS(B)
 D62 : MA3100-M
 D401 : B30-1669-05
- SIGNAL LINE
 GND LINE
 +B LINE
 -B LINE
- SP OUT**
 T1 200W / 4Ω
 T2 400W / 2Ω
 T3 500W / 1Ω
 T4 1, 2, 3, 4
 T5 P-CON
 T6 GND
 T7 BATT.
 FUSE
- KAC-8101D/8151D**
- (X09-) (B/2)

DTC124EUA

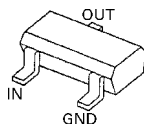

TC4052BF

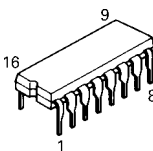

NJM2903M
NJM4565M
NJM5532MD

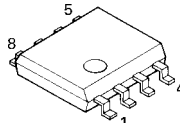

UPC494GS

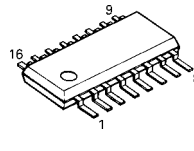

TC74HC00AF

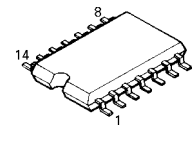

EXPLODED VIEW

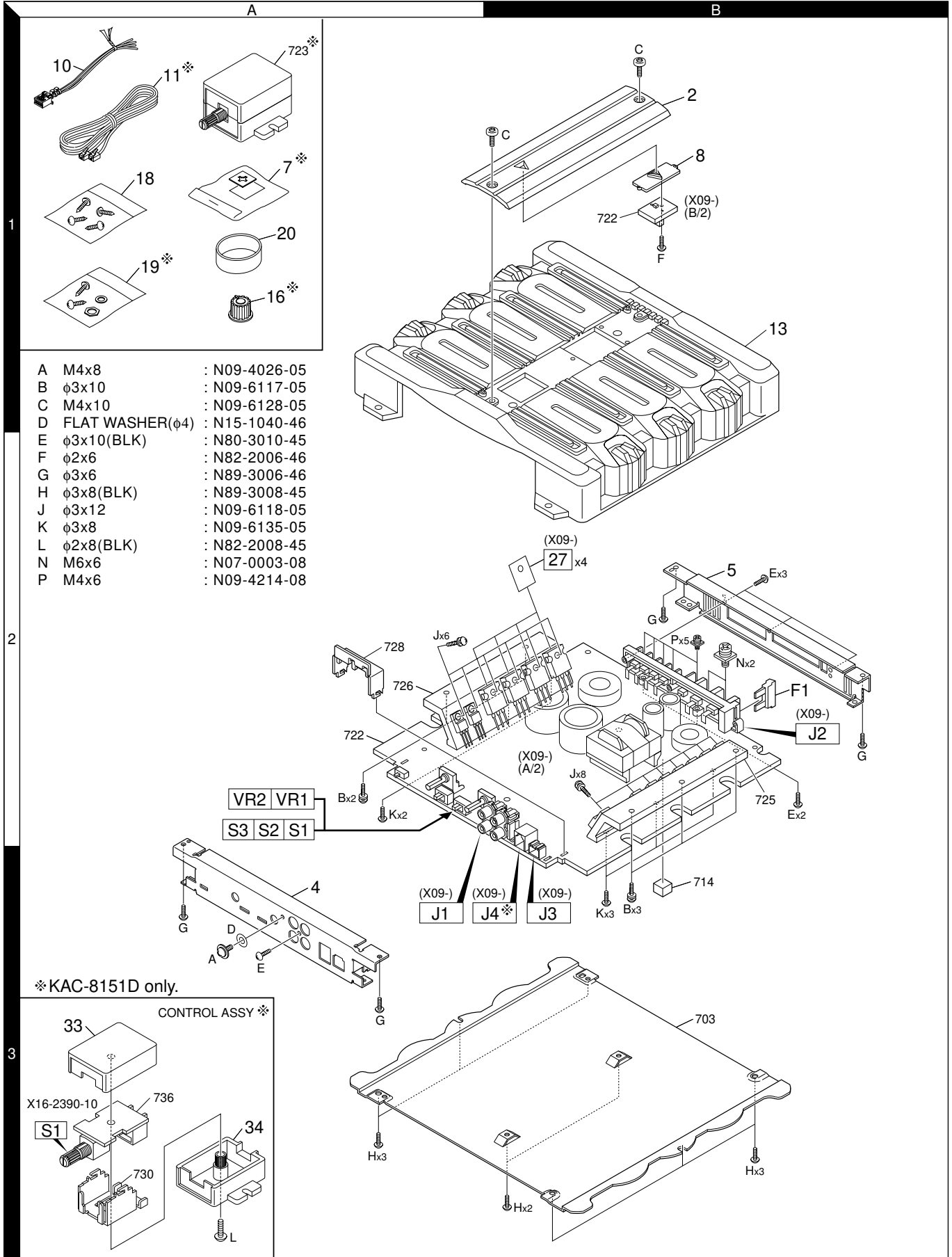

KAC-8101D/8151D

PARTS LIST

* New parts

Parts without **Parts No.** are not supplied.

Les articles non mentionnes dans le **Parts No.** ne sont pas fournis.

Teile ohne **Parts No.** werden nicht geliefert.

Ref. No.	A d	N e w	Parts No.	Description	Desti- nation
2	1B	*	A21-4271-03	DRESSING PANEL	KE1
2	1B	*	A21-4288-03	DRESSING PANEL	K1
4	3A	*	A64-3054-02	PANEL	KE1
4	3A	*	A64-3094-02	PANEL	K1
5	2B	*	A84-0348-02	REAR PANEL	
7	1A	*	B03-5024-14	DRESSING PLATE	KE1
8	1B	*	B19-2214-13	LIGHTING BOARD	
-		*	B46-0100-50	WARRANTY CARD	
-		*	B64-2577-00	INSTRUCTI.MANUAL (ENG.FRE.SPA.)	
-		*	B64-2578-00	INSTR.MANUAL (GER.DUT.ITA.POR.)	E1
10	1A		E30-6145-05	CONNECTING CORD ASSY	
11	1A		E30-6240-15	MODULAR CABLE	KE1
13	1B	*	F01-1729-11	HEAT SINK	
△ F1	2B		F52-0016-05	FUSE (BLADE TYPE) 40A	
-		*	H10-4870-13	POLYSTYRENE FOAMED FIXTURE	
-		*	H25-0336-04	PROTECTION BAG (170X250X0.03)	
-		*	H25-1179-04	PROTECTION BAG	KE1
-		*	H25-1192-04	PROTECTION BAG (370X440)	
-		*	H54-2881-03	ITEM CARTON CASE	E1
-		*	H54-2882-13	ITEM CARTON CASE	K1
-		*	H54-2926-03	ITEM CARTON CASE	K
16	1A		K23-1076-03	KNOB	KE1
18	1A		N99-1587-05	SCREW SET	
19	1A		N99-1740-05	SCREW SET	KE1
A	3A		N09-4026-05	TAPPING SCREW (4X8,TP,S)	
B	2A		N09-6117-05	TAPTITE SCREW	
C	1B		N09-6128-05	DRESSED SCREW (TORX)	
D	3A		N15-1040-46	FLAT WASHER (4)	
E	2B		N80-3010-45	PAN HEAD TAPTITE SCREW	
F	1B		N82-2006-46	BINDING HEAD TAPTITE SCREW	
G	2B		N89-3006-46	BINDING HEAD TAPTITE SCREW	
H	3B		N89-3008-45	BINDING HEAD TAPTITE SCREW	
N	2B		N07-0003-08	PAN HEAD SEMS SCREW	
P	2B		N09-4214-08	PAN HEAD SEMS SCREW	
20	1A		W01-1606-05	ACCESSORY	
D401			B30-1669-05	LED (BLUE)	
C1,2			CF92FV1H102J	MF-C 1000PF J	
C3-8			CE04DW1V100M	ELECTRO 10UF 35WV	
C10			CK73GB1H103K	CHIP C 0.010UF K	
C21,22			CK73GB1H103K	CHIP C 0.010UF K	
C23			CC73GCH1H330J	CHIP C 33PF J	
C24			CC73GCH1H470J	CHIP C 47PF J	
C25			CC73GCH1H100D	CHIP C 10PF D	
C26			CC73GCH1H330J	CHIP C 33PF J	
C27			CC73GCH1H100D	CHIP C 10PF D	
C28			CE04DW1V100M	ELECTRO 10UF 35WV	
C31,32			CK73GB1H103K	CHIP C 0.010UF K	
C33			CF92FV1H224J	MF-C 0.22UF J	

Ref. No.	A d	N e w	Parts No.	Description	Desti- nation
C34			CE04HW1H2R2M	NP-ELEC 2.2UF 50WV	
C35			CC73GCH1H471J	CHIP C 470PF J	
C36			CK73FB1C474K	CHIP C 0.47UF K	
C37,38			CK73GB1H103K	CHIP C 0.010UF K	KE1
C39,40			CC73GCH1H101J	CHIP C 100PF J	KE1
C51,52			CK73GB1H103K	CHIP C 0.010UF K	
C53			CK73FB1C474K	CHIP C 0.47UF K	
C54			CK73FB1E154K	CHIP C 0.15UF K	
C55			CE04DW1V100M	ELECTRO 10UF 35WV	
C57-59			CE04DW1H010M	ELECTRO 1.0UF 50WV	
C60			CE04DW1V100M	ELECTRO 10UF 35WV	
C61,62			CK73GB1H103K	CHIP C 0.010UF K	
C63			CE04DW1H2R2M	ELECTRO 2.2UF 50WV	
C64			CK73GB1H103K	CHIP C 0.010UF K	
C65			CE04DW1V100M	ELECTRO 10UF 35WV	
C66-68			CK73GB1H103K	CHIP C 0.010UF K	
C69			CE04DW1V100M	ELECTRO 10UF 35WV	
C71			CC73GCH1H101J	CHIP C 100PF J	
C72			CE04DW1V100M	ELECTRO 10UF 35WV	
C101,102			CK73GB1H103K	CHIP C 0.010UF K	
C103			CF92FV1H182J	MF-C 1800PF J	
C104			CK73GB1H103K	CHIP C 0.010UF K	
C105,106			CE04DW1V100M	ELECTRO 10UF 35WV	
C111			CE04DW1H010M	ELECTRO 1.0UF 50WV	
C112			CK73GB1H104K	CHIP C 0.10UF K	
C113			CE04DW1E470M	ELECTRO 47UF 25WV	
C114			CC73GCH1H470J	CHIP C 47PF J	
C115			CF92FV1H392J	MF-C 3900PF J	
C131			CE04DW1E470M	ELECTRO 47UF 25WV	
C132,133			CC45FCH1H390J	CERAMIC 39PF J	
C151,152		*	CF92FV2A104J	MF-C 0.10UF J	
C153,154			CF92FV1H682J	MF-C 6800PF J	
C155,156			C91-2267-05	MP-C 10UF J	
C171			CK73GB1H103K	CHIP C 0.010UF K	
C191,192			CK73GB1E473K	CHIP C 0.047UF K	
C193			CE04DW1E470M	ELECTRO 47UF 25WV	
C194			CK73GB1H103K	CHIP C 0.010UF K	
C195			CK73GB1H682K	CHIP C 6800PF K	
C201,202			CK73GB1H103K	CHIP C 0.010UF K	
C203,204			CE04DW1V100M	ELECTRO 10UF 35WV	
C205			CK73FB1C684K	CHIP C 0.68UF K	
C206			CK73GB1H103K	CHIP C 0.010UF K	
C231			CE04DW1A101M	ELECTRO 100UF 10WV	
C232			CK73GB1H103K	CHIP C 0.010UF K	
C251			CE04HW1E100M	NP-ELEC 10UF 25WV	
C252,253			CE04DW1V100M	ELECTRO 10UF 35WV	
C254			CK73GB1H103K	CHIP C 0.010UF K	
C255			CE04DW1V100M	ELECTRO 10UF 35WV	
C256			CK73GB1H103K	CHIP C 0.010UF K	
C257			CK73FB1E104K	CHIP C 0.10UF K	
C271			CK73GB1H103K	CHIP C 0.010UF K	
C272			CE04HW1H2R2M	NP-ELEC 2.2UF 50WV	
C273			CE04DW1H0R1M	ELECTRO 0.1UF 50WV	
C274			CF92FV1H102J	MF-C 1000PF J	
C275			CE04DW1E470M	ELECTRO 47UF 25WV	

E1 : KAC-8151D (For Europe) K : KAC-8151D (For North America)

K1 : KAC-8101D (For North America)

△ Indicates safety critical components.

PARTS LIST

* New parts

Parts without **Parts No.** are not supplied.

Les articles non mentionnés dans le **Parts No.** ne sont pas fournis.

Teile ohne **Parts No.** werden nicht geliefert.

AUDIO UNIT (X09-5480-1x)

Ref. No.	Add	New	Parts No.	Description	Destination	Ref. No.	Add	New	Parts No.	Description	Destination
C276			CE04DW1V100M	ELECTRO 10UF 35WV		R56			RK73GB2A103J	CHIP R 10K J 1/10W	
C302,303			C90-2921-05	ELECTRO 3900UF 16WV		R61			RK73GB2A243J	CHIP R 24K J 1/10W	
C304			CF92FV1H682J	MF-C 6800PF J		R62			RK73GB2A104J	CHIP R 100K J 1/10W	
C309-312			CK45FB1H102K	CERAMIC 1000PF K		R63			RK73GB2A103J	CHIP R 10K J 1/10W	
C313,314		*	C90-5497-05	ELECTRO 3300UF 63WV		R64			RK73GB2A223J	CHIP R 22K J 1/10W	
C315-318			CE04DW1E470M	ELECTRO 47UF 25WV		R65-68			RK73GB2A472J	CHIP R 4.7K J 1/10W	
C319			CE04DW1V470M	ELECTRO 47UF 35WV		R69			RK73GB2A473J	CHIP R 47K J 1/10W	
C320			CE04DW1E470M	ELECTRO 47UF 25WV		R71,72			RK73GB2A563J	CHIP R 56K J 1/10W	
C321			CK45FB1H222K	CERAMIC 2200PF K		R101,102			RD14BB2E151J	RD 150 J 1/4W	
C401			CK73GB1H103K	CHIP C 0.010UF K		R103			RK73GB2A152J	CHIP R 1.5K J 1/10W	
CN1			E40-3247-05	PIN ASSY		R104			RK73GB2A821J	CHIP R 820 J 1/10W	
J1		*	E63-0892-05	PIN JACK		R105			RK73GB2A472J	CHIP R 4.7K J 1/10W	
J2			E70-0838-05	SCREW TERMINAL BOARD		R106			RK73GB2A103J	CHIP R 10K J 1/10W	
J3			E58-0919-05	RECTANGULAR RECEPTACLE		R107			RK73GB2A302J	CHIP R 3.0K J 1/10W	
J4			E58-0966-05	RECTANGULAR RECEPTACLE	KE1	R108			RK73GB2A103J	CHIP R 10K J 1/10W	
WH1			E39-0538-05	WIRING HARNESS		R111			RK73GB2A154J	CHIP R 150K J 1/10W	
27	2B	*	F20-2205-14	INSULATING SHEET		R112			RK73GB2A104J	CHIP R 100K J 1/10W	
L2		*	L19-0738-05	TRANSFORMER FOR CONVERTER		R113			RK73GB2A333J	CHIP R 33K J 1/10W	
L3		*	L33-1911-05	CHOKO COIL		R114			RK73GB2A103J	CHIP R 10K J 1/10W	
L4			L33-1818-05	CHOKO COIL		R115			RK73GB2A822J	CHIP R 8.2K J 1/10W	
E	2B		N80-3010-45	PAN HEAD TAPTITE SCREW		R116			RK73GB2A823J	CHIP R 82K J 1/10W	
J	2A		N09-6118-05	TAPTITE SCREW		R117,118			RK73GB2A102J	CHIP R 1.0K J 1/10W	
K	2A	*	N09-6135-05	TAPTITE SCREW (3X8 B)		R119			RK73GB2A684J	CHIP R 680K J 1/10W	
R1,2			RD14BB2C102J	RD 1.0K J 1/6W		R122			RK73GB2A471J	CHIP R 470 J 1/10W	
R3,4			RK73GB2A103J	CHIP R 10K J 1/10W		R123			RK73GB2A683J	CHIP R 68K J 1/10W	
R5,6			RK73GB2A273J	CHIP R 27K J 1/10W		R124			RD14BB2E243J	RD 24K J 1/4W	
R7,8			RD14BB2C222J	RD 2.2K J 1/6W		R131			RD14BB2C751J	RD 750 J 1/6W	
R9-12			RD14BB2C473J	RD 47K J 1/6W		R132			RK73GB2A511J	CHIP R 510 J 1/10W	
R13			RK73GB2A102J	CHIP R 1.0K J 1/10W		R133,134			RK73GB2A103J	CHIP R 10K J 1/10W	
R21			RK73GB2A153J	CHIP R 15K J 1/10W		R135,136			RK73GB2A102J	CHIP R 1.0K J 1/10W	
R22			RK73GB2A103J	CHIP R 10K J 1/10W		R141,142			RD14DB2H751J	SMALL-RD 750 J 1/2W	
R23			RK73GB2A333J	CHIP R 33K J 1/10W		R143,144			RD14NB2E471J	RD 470 J 1/4W	
R24-27			RN73GH1J103D	CHIP R 10K D 1/16W		R145			RD14NB2E470J	RD 47 J 1/4W	
R28			RD14BB2C103J	RD 10K J 1/6W		R146			RD14NB2E271J	RD 270 J 1/4W	
R29			RK73GB2A431J	CHIP R 430 J 1/10W		R147-150			RK73EB2E100J	CHIP R 10 J 1/4W	
R31			RK73GB2A243J	CHIP R 24K J 1/10W		R151			RD14NB2E331J	RD 330 J 1/4W	
R32			RK73GB2A301J	CHIP R 300 J 1/10W		R152			RD14NB2E122J	RD 1.2K J 1/4W	
R33,34			RK73GB2A224J	CHIP R 220K J 1/10W		R153-156			RD14NB2E101J	RD 100 J 1/4W	
R35			RK73GB2A221J	CHIP R 220 J 1/10W		R157,158			RK73GB2A473J	CHIP R 47K J 1/10W	
R36			RK73GB2A102J	CHIP R 1.0K J 1/10W		R159-162			RK73EB2E100J	CHIP R 10 J 1/4W	
R37			RK73GB2A222J	CHIP R 2.2K J 1/10W		R163			RS14KB3D4R7J	FL-PROOF RS 4.7 J 2W	
R38			RK73GB2A103J	CHIP R 10K J 1/10W		R171			RD14DB2H152J	SMALL-RD 1.5K J 1/2W	
R39			RK73GB2A471J	CHIP R 470 J 1/10W		R172			RK73GB2A473J	CHIP R 47K J 1/10W	
R40			RK73GB2A332J	CHIP R 3.3K J 1/10W		R173			RD14DB2H102J	SMALL-RD 1.0K J 1/2W	
R41-43			RD14BB2C102J	RD 1.0K J 1/6W	KE1	R174			RK73GB2A103J	CHIP R 10K J 1/10W	
R45,46			RD14BB2C122J	RD 1.2K J 1/6W	KE1	R181-186			R92-0205-05	METAL-PLATE 0.1 K 2W	
R47			RK73GB2A331J	CHIP R 330 J 1/10W		R191,192			RK73GB2A332J	CHIP R 3.3K J 1/10W	
R48			RK73GB2A681J	CHIP R 680 J 1/10W		R193			RK73GB2A822J	CHIP R 8.2K J 1/10W	
R49,50			RK73GB2A473J	CHIP R 47K J 1/10W	KE1	R194			RK73GB2A332J	CHIP R 3.3K J 1/10W	
R51			RK73GB2A102J	CHIP R 1.0K J 1/10W		R195	*		RK73GB2A514J	CHIP R 510K J 1/10W	
R52			RK73GB2A223J	CHIP R 22K J 1/10W		R196,197			RN73GH1J472D	CHIP R 4.7K D 1/16W	
R54			RK73GB2A303J	CHIP R 30K J 1/10W		R198			RK73GB2A393J	CHIP R 39K J 1/10W	
R55			RK73GB2A392J	CHIP R 3.9K J 1/10W		R199			RK73GB2A222J	CHIP R 2.2K J 1/10W	

E1 : KAC-8151D (For Europe) K : KAC-8151D (For North America)

K1 : KAC-8101D (For North America)

△ Indicates safety critical components.

PARTS LIST

* New parts

Parts without **Parts No.** are not supplied.

Les articles non mentionnés dans le **Parts No.** ne sont pas fournis.

Teile ohne **Parts No.** werden nicht geliefert.

AUDIO UNIT (X09-5480-1x)

Ref. No.	A d	N e w	Parts No.	Description	Desti- nation	Ref. No.	A d	N e w	Parts No.	Description	Desti- nation
R200			RK73GB2A273J	CHIP R 27K J 1/10W		R322			RK73GB2A100J	CHIP R 10 J 1/10W	
R201			RK73GB2A222J	CHIP R 2.2K J 1/10W		R323			RK73GB2A153J	CHIP R 15K J 1/10W	
R202			RK73GB2A103J	CHIP R 10K J 1/10W		R324			RK73GB2A562J	CHIP R 5.6K J 1/10W	
R203			RK73GB2A104J	CHIP R 100K J 1/10W		R325			RK73GB2A563J	CHIP R 56K J 1/10W	
R205			RK73GB2A104J	CHIP R 100K J 1/10W		R326			RD14DB2H100J	SMALL-RD 10 J 1/2W	
R211			RK73GB2A473J	CHIP R 47K J 1/10W		VR1			R31-0223-05	VARIABLE RESISTOR	
R212			RK73GB2A103J	CHIP R 10K J 1/10W		VR2			R31-0229-05	VARIABLE RESISTOR	
R213-215			RK73GB2A203J	CHIP R 20K J 1/10W		W501-516			R92-2053-05	CHIP R 0 J 1/8W	
R216			RK73GB2A103J	CHIP R 10K J 1/10W		S1			S62-0845-05	SLIDE SWITCH	
R217			RK73GB2A132J	CHIP R 1.3K J 1/10W		S2			S31-2630-05	SLIDE SWITCH	
R218			RK73GB2A123J	CHIP R 12K J 1/10W		S3			S62-0842-05	SLIDE SWITCH	
R219			RK73GB2A203J	CHIP R 20K J 1/10W		D1-5			1SS133	DIODE	
R220			RK73GB2A224J	CHIP R 220K J 1/10W		D6,7			RD10JS(B)	ZENER DIODE	
R221			RK73GB2A103J	CHIP R 10K J 1/10W		D8,9			1SS133	DIODE	
R222			RK73GB2A102J	CHIP R 1.0K J 1/10W		D10			RD5.1JS(B)	ZENER DIODE	
R231			RK73GB2A823J	CHIP R 82K J 1/10W		D11,12			1SS133	DIODE	
R232			RK73GB2A103J	CHIP R 10K J 1/10W		D13			RD5.1JS(B)	ZENER DIODE	
R233,234			RK73GB2A223J	CHIP R 22K J 1/10W		D14-17			1SS133	DIODE	
R251-254			RK73GB2A332J	CHIP R 3.3K J 1/10W		D18			RD5.1JS(B)	ZENER DIODE	
R255			RK73GB2A103J	CHIP R 10K J 1/10W		D19			1SS133	DIODE	
R256			RK73GB2A472J	CHIP R 4.7K J 1/10W		D20			RD4.7JS(B)	ZENER DIODE	
R257			RK73GB2A333J	CHIP R 33K J 1/10W		D21,22			1SS133	DIODE	
R258			RK73GB2A472J	CHIP R 4.7K J 1/10W		D30			MA111	DIODE	
R259			RD14BB2C333J	RD 33K J 1/6W		D31,32			RM4ZLF-J1	DIODE	
R260			RD14BB2C103J	RD 10K J 1/6W		D33			RD7.5JS(B)	ZENER DIODE	
R261			RK73GB2A333J	CHIP R 33K J 1/10W		D34			RD16JS(B)	ZENER DIODE	
R262			RK73GB2A103J	CHIP R 10K J 1/10W		D35,36			1SS133	DIODE	
R263			RK73GB2A101J	CHIP R 100 J 1/10W		D37			RD10JS(B)	ZENER DIODE	
R264			RK73GB2A103J	CHIP R 10K J 1/10W		D38-40			1SS133	DIODE	
R265,266			RK73GB2A681J	CHIP R 680 J 1/10W		D41,42			MA111	DIODE	
R267			RK73GB2A222J	CHIP R 2.2K J 1/10W		D43,44			1SS133	DIODE	
R271			RK73GB2A103J	CHIP R 10K J 1/10W		D45			FML22S	DIODE	
R272			RK73GB2A222J	CHIP R 2.2K J 1/10W		D46			FML22R	DIODE	
R273,274			RK73GB2A273J	CHIP R 27K J 1/10W		D47,48			RD16JS(B)	ZENER DIODE	
R275			RK73GB2A334J	CHIP R 330K J 1/10W		D49-52			S5566B	DIODE	
R276			RK73GB2A103J	CHIP R 10K J 1/10W		D53			RD15JS(B)	ZENER DIODE	
R277			RK73GB2A152J	CHIP R 1.5K J 1/10W		D54-57			1SS133	DIODE	KE1
R278			RK73GB2A102J	CHIP R 1.0K J 1/10W		D58,59			RD8.2JS(B)	ZENER DIODE	KE1
R279			RK73GB2A103J	CHIP R 10K J 1/10W		D60			1SS133	DIODE	
R280			RK73GB2A392J	CHIP R 3.9K J 1/10W		D62			MA3100-M	ZENER DIODE	
R281			RK73GB2A102J	CHIP R 1.0K J 1/10W		D71,72			RD10JS(B)	ZENER DIODE	
R282			RK73GB2A163J	CHIP R 16K J 1/10W		D73-76			1SS133	DIODE	
R283,284			RK73GB2A103J	CHIP R 10K J 1/10W		IC1-5			NJM4565M	ANALOGUE IC	
R301,302			RK73GB2A152J	CHIP R 1.5K J 1/10W		IC6			SA571N	ANALOGUE IC	
R303,304			RK73GB2A750J	CHIP R 75 J 1/10W		IC7			NJM5532MD	ANALOGUE IC	
R305,306			RK73GB2A100J	CHIP R 10 J 1/10W		IC8			NJM2903M	ANALOGUE IC	
R307,308			RK73GB2A472J	CHIP R 4.7K J 1/10W		IC9			NJM319D	ANALOGUE IC	
R309			RD14DB2H100J	SMALL-RD 10 J 1/2W		IC10,11			TC74HC00AF	MOS-IC	KE1
R311,312			RD14DB2H220J	SMALL-RD 22 J 1/2W		IC12			TC4052BF(N)	MOS-IC	
R313,314			RD14BB2C563J	RD 56K J 1/6W		IC15			UPC494GS	ANALOGUE IC	
R315,316			RD14NB2E100J	RD 10 J 1/4W		Q1			2SC945(A)(Q,P)	TRANSISTOR	
R317,318			RD14BB2C243J	RD 24K J 1/6W		Q3,4			2SC2631(Q,R)	TRANSISTOR	
R319			RK73GB2A821J	CHIP R 820 J 1/10W		Q5			2SA1352(E,F)	TRANSISTOR	
R320			RK73GB2A472J	CHIP R 4.7K J 1/10W		Q7-10			2SA1352(E,F)	TRANSISTOR	
R321			RK73GB2A103J	CHIP R 10K J 1/10W							

E1 : KAC-8151D (For Europe) K : KAC-8151D (For North America)

K1 : KAC-8101D (For North America)

△ Indicates safety critical components.

PARTS LIST

* New parts

Parts without **Parts No.** are not supplied.

Les articles non mentionnés dans le **Parts No.** ne sont pas fournis.

Teile ohne **Parts No.** werden nicht geliefert.

AUDIO UNIT (X09-5480-1x)

Ref. No.	A	N	Parts No.	Description	Desti-	Ref. No.	A	N	Parts No.	Description	Desti-
	d	w			nation		d	w			nation
Q11			2SC3478A(L,K)	TRANSISTOR							
Q12,13			2SA1286-T11	TRANSISTOR							
Q14			2SC3478A(L,K)	TRANSISTOR							
Q15,16			STW34NB20	FET							
Q17			2SC3478A(L,K)	TRANSISTOR							
Q18,19			2SA1376A(L,K)	TRANSISTOR							
Q20			2SC3478A(L,K)	TRANSISTOR							
Q21			2SC2631(Q,R)	TRANSISTOR							
Q22			2SA1123(Q,R)	TRANSISTOR							
Q23,24			2SC945(A)(Q,P)	TRANSISTOR							
Q25			2SA733(A)(Q,P)	TRANSISTOR							
Q26			2SA1376A(L,K)	TRANSISTOR							
Q27			2SC3478A(L,K)	TRANSISTOR							
Q28			DTC124EUA	DIGITAL TRANSISTOR							
Q31,32			2SC945(A)(Q,P)	TRANSISTOR							
Q33			2SA1534A(R,S)	TRANSISTOR							
Q34			2SA733(A)(Q,P)	TRANSISTOR							
Q36-38			2SC945(A)(Q,P)	TRANSISTOR							
Q39,40			2SA733(A)(Q,P)	TRANSISTOR							
Q41-46			FKV550T	FET							
Q47			2SC1845(F,E)	TRANSISTOR							
Q48			2SA992(F,E)	TRANSISTOR							
Q49			2SC4883A	TRANSISTOR							
Q50			2SA1859A	TRANSISTOR							
Q51,52			2SA733(A)(Q,P)	TRANSISTOR							
Q53			2SC3940A(R,S)	TRANSISTOR							
Q55			2SC945(A)(Q,P)	TRANSISTOR							
Q61,62			2SC3478A(L,K)	TRANSISTOR							
Q63,64			2SA1286-T11	TRANSISTOR							
Q65,66			STW34NB20	FET							
TH1			PTH9L04BE222TS	POSITIVE RESISTOR							
J1			E58-0966-05	RECTANGULAR RECEPTACLE	KE1						
S1			S60-0807-05	ROTARY SWITCH	KE1						
D1,2			1SS133	DIODE	KE1						
33	3A	*	A02-2728-12	PLASTIC CABINET	KE1						
34	3A		A02-2729-02	PLASTIC CABINET	KE1						
-		*	H25-1187-04	PROTECTION BAG	KE1						
L	3A		N82-2008-45	BINDING HEAD TAPTITE SCREW	KE1						

E1 : KAC-8151D (For Europe) K : KAC-8151D (For North America)
 K1 : KAC-8101D (For North America)

△ Indicates safety critical components.

KAC-8101D/8151D

SPECIFICATIONS

Audio Section

Max Power Output	1000W x 1
Rated Power Output	
(4Ω) (20Hz~200Hz, 0.5% THD)	200W x 1
(4Ω) (DIN : 45324 , +B=14.4V)	200W x 1
(2Ω) (100Hz, 0.5% THD)	400W x 1
(1Ω) (100Hz, 1.0% THD)	500W x 1
Frequency Response (+0, -3dB)	5Hz~200Hz
Sensitivity (rated output) (MAX.)	0.2V
Sensitivity (rated output) (MIN.)	5.0V
Signal to Noise Ratio	100dB
Input Impedance	10kΩ
Low Pass Filter Frequency (18dB/oct.)	50~200Hz (variable)
Infrasonic Filter Frequency (18dB/oct.)	OFF/15/25Hz
Bass Boost Circuit (90Hz)	
KAC-8151D	OFF/+6/+9/+12dB
KAC-8101D	OFF/+12dB

General

Operating Voltage	14.4V (11~16V allowable)
Current Consumption (4Ω, 10% THD)	31A
Dimensions (W x H x D)	285 x 57 x 268 mm
	11-1/4 x 2-1/4 x 10-9/16 inch
Weight	2.96kg (6.5 lbs)

KENWOOD follows a policy of continuous advancements in development. For this reason specifications may be changed without notice.

KENWOOD CORPORATION

2967-3, Ishikawa-machi, Hachioji-shi, Tokyo 192-8525, Japan

KENWOOD USA CORPORATION

P.O. BOX 22745, 2201 East Dominguez Street, Long Beach, CA90801-5745, U.S.A.

KENWOOD ELECTRONICS CANADA INC.

6070 Kestrel Road, Mississauga, Ontario, Canada L5T 1S8

KENWOOD ELECTRONICS LATIN AMERICA S.A.

P.O. Box 55-2791 Pañilla, Plaza Credicorp Bank Panama,
Piso 9, Oficina 901, Calle 50, Panama, Rep. de Panama

KENWOOD ELECTRONICS BRASIL LTDA.

Alameda Ministro Rocha Azevedo No. 456,
Edifício Jaú, 10o Andar, Cerqueira César, Cep 0140-001,
São Paulo-SP-Brasil

KENWOOD ELECTRONICS UK LIMITED

Kenwood House, Dwight Road, Watford, Herts, WD18 9EB, United Kingdom

KENWOOD ELECTRONICS DEUTSCHLAND GMBH

Rembrücker-Str. 15, 63150 Heusenstamm, Germany

KENWOOD ELECTRONICS FRANCE S.A.

13, Boulevard Ney, 75018 Paris, France

KENWOOD ELECTRONICS BELGIUM N.V.

Leuvensesteenweg 248 J, 1800 Vilvoorde, Belgium

KENWOOD ELECTRONICS ITALIA S.p.A.

Via G. Sirtori 7/9, 20129 Milano, Italy

KENWOOD IBÉRICA S.A.

Bolivia, 239-08020 Barcelona, Spain

KENWOOD ELECTRONICS AUSTRALIA PTY. LTD. (A.C.N. 001 499 074)

16 Giffnock Avenue, Centrecourt Estate, North Ryde,
N.S.W. 2113, Australia

KENWOOD ELECTRONICS (HONG KONG) LTD.

Unit 3712-3724, Level 37, Tower 1, Metroplaza, 223 Hing Fong Road, Kwai Fong, N.T.,
Hong Kong

KENWOOD ELECTRONICS GULF FZE

P.O. Box 61318, Jebel Ali, Dubai, U.A.E.

KENWOOD ELECTRONICS (THAILAND) CO., LTD.

2019 New Pechburi Road, Bangkapi, Huaykwang, Bangkok, 10320 Thailand

KENWOOD ELECTRONICS SINGAPORE PTE. LTD.

1 Genting Lane, #07-00, Kenwood Building, Singapore, 349544

KENWOOD ELECTRONICS (MALAYSIA) SDN BHD

#4.01 Level 4, Wisma Academy Lot 4A, Jalan 19/1, 46300 Petaling Jaya, Selangor Darul Ehsan,
Malaysia